

TEXTURAS



SLATE

TXSL



WOOD

TXWO



SMOOTH  
(plato)

TXSM1

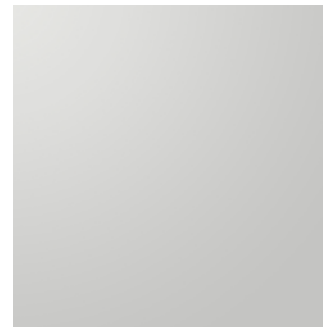

SMOOTH  
(panel/encimera)

TXSM2



EVOLUTION

TXEV



CEMENT

TXCE

COLORES

	Blanco RAL9003		Marfil RAL1013		Perla RAL9002
	Gris claro RAL7047		Gris piedra RAL7044		Hormigón RAL7037
	Gris plata RAL7036		Arena RAL1001		Topo RAL7039
	Antracita RAL7015		Gris oliva RAL1019		Moka RAL8025
	Negro RAL9005		Chocolate RAL8011		Wengué RAL8017

**MEDIDAS**

**SLATE**

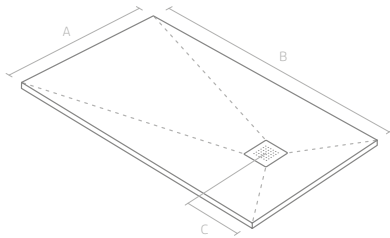

A	B										
	80	90	100	120	140	150	160	170	180	190	200
70	-	-	50	30	30	30	30	30	30	30	30
80	40	-	50	30	30	30	30	30	30	30	30
90	-	45	50	30	30	30	30	30	30	30	30
100	-	-	50	30	30	30	30	30	30	30	30

Distancia a desagüe (C)

**SLATE**

NMEDSL

\*imagen única incluyendo dibujo técnico y tabla de medidas

**STONE**

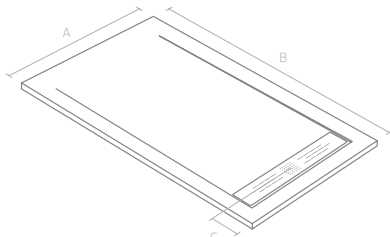

A	B					
	120	140	160	180	190	200
70	13	13	13	13	13	13
80	13	13	13	13	13	13
90	13	13	13	13	13	13
100	13	13	13	13	13	13

Distancia a desagüe (C)

**STONE**

NMEDST

\*imagen única incluyendo dibujo técnico y tabla de medidas

**WOOD**

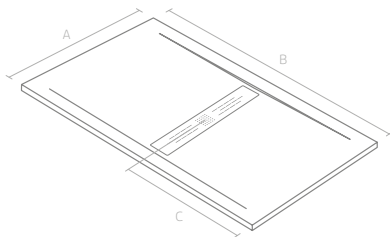

A	B			
	100	120	140	160
70	50	60	70	80
80	50	60	70	80
90	50	60	70	80
100	50	60	70	80

Distancia a desagüe (C)

**WOOD**

NMEDWO

\*imagen única incluyendo dibujo técnico y tabla de medidas

**MEDIDAS**

**SMOOTH**

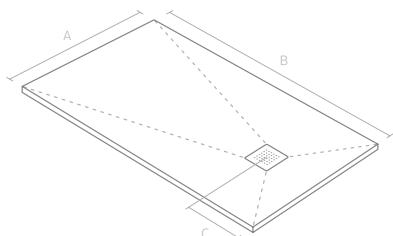

A

B

	80	90	100	120	140	150	160	170	180	190	200
70	-	-	50	30	30	30	30	30	30	30	30
80	40	-	50	30	30	30	30	30	30	30	30
90	-	45	50	30	30	30	30	30	30	30	30
100	-	-	50	30	30	30	30	30	30	30	30

Distancia a desagüe (C)

**SMOOTH**

NMEDSM

\*imagen única incluyendo dibujo técnico y tabla de medidas

**EVOLUTION**

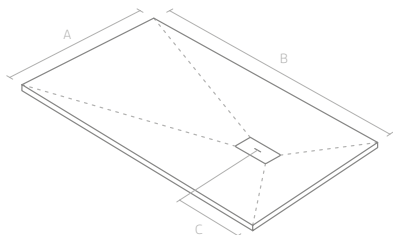

A

B

	80	90	100	120	140	150	160	170	180	190	200
70	-	-	30	30	30	30	30	30	30	30	30
80	30	-	30	30	30	30	30	30	30	30	30
90	-	30	30	30	30	30	30	30	30	30	30
100	-	-	30	30	30	30	30	30	30	30	30

Distancia a desagüe (C)

**EVOLUTION**

NMEDEV

\*imagen única incluyendo dibujo técnico y tabla de medidas

**CEMENT**

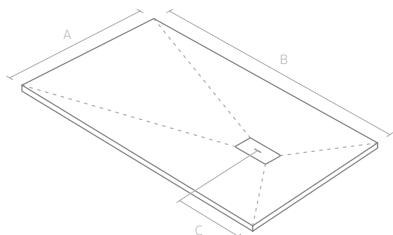

A

B

	100	120	140	150	160	170	180
70	30	30	30	30	30	30	30
80	30	30	30	30	30	30	30
90	30	30	30	30	30	30	30
100	30	30	30	30	30	30	30

Distancia a desagüe (C)

**CEMENT**

NMEDCE

\*imagen única incluyendo dibujo técnico y tabla de medidas

**MEDIDAS**

**INFINITY**

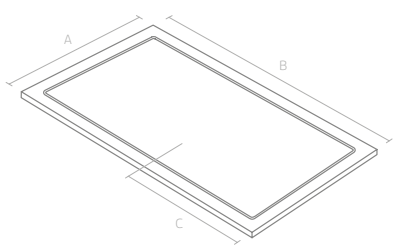

	B			
	100	120	140	160
70	50	60	70	80
80	50	60	70	80
90	50	60	70	80
100	50	60	70	80

Distancia a desagüe (C)

INFINITY

NMEDIN

\*imagen única incluyendo dibujo técnico y tabla de medidas

**NATURE**

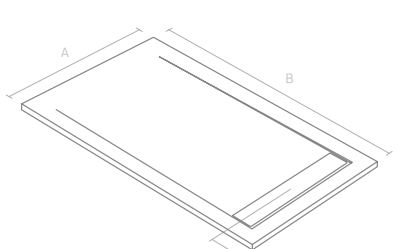

	B					
	120	140	160	180	190	200
70	13	13	13	13	13	13
80	13	13	13	13	13	13
90	13	13	13	13	13	13
100	13	13	13	13	13	13

Distancia a desagüe (C)

NATURE

NMEDNA

\*imagen única incluyendo dibujo técnico y tabla de medidas

**CURVE**

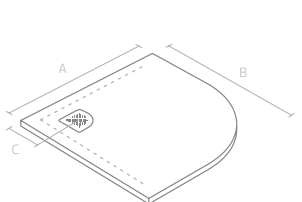

	B	
	80	90
70	-	-
80	25	-
90	-	25
100	-	-

Distancia a desagüe (C)

CURVE

NMEDCU

\*imagen única incluyendo dibujo técnico y tabla de medidas

**MEDIDAS**

**GRAVITZERO®**

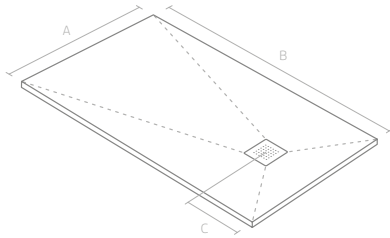

	B											
	80	90	100	120	140	150	160	170	180	190	200	
70	-	-	50	30	30	30	30	30	30	30	30	30
80	40	-	50	30	30	30	30	30	30	30	30	30
90	-	45	50	30	30	30	30	30	30	30	30	30
100	-	-	50	30	30	30	30	30	30	30	30	30

Distancia a desagüe (C)

GRAVITZERO®

NMEDGR

\*imagen única incluyendo dibujo técnico y tabla de medidas

**CREATIVESKIN®**

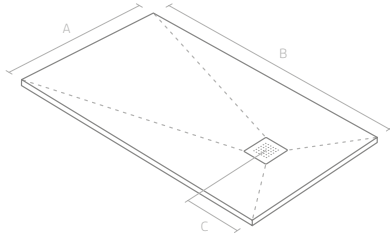

	B										
	80	90	100	120	140	150	160	170	180	190	200
70	-	-	50 <sup>N</sup>	30 <sup>N</sup>	30 <sup>N</sup>	30 <sup>N</sup>	30 <sup>N</sup>	30	30	30	30
80	40 <sup>N</sup>	-	50 <sup>N</sup>	30 <sup>N</sup>	30 <sup>N</sup>	30 <sup>N</sup>	30 <sup>N</sup>	30	30	30	30
90	-	45 <sup>N</sup>	50 <sup>N</sup>	30 <sup>N</sup>	30 <sup>N</sup>	30 <sup>N</sup>	30 <sup>N</sup>	30	30	30	30
100	-	-	50 <sup>N</sup>	30 <sup>N</sup>	30 <sup>N</sup>	30 <sup>N</sup>	30 <sup>N</sup>	30	30	30	30

Distancia a desagüe (C)

<sup>N</sup> Medidas disponibles para modelos Naturalia.

CREATIVESKIN®

NMEDCR

\*imagen única incluyendo dibujo técnico y tabla de medidas

**TEXPANEL**

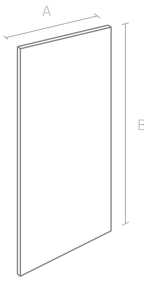

**A** hasta 110

**B** hasta 210

\*Grosor: 1 cm  
(margen de +/- 2 mm)

TEXPANEL

NMEDTE

\*imagen única incluyendo dibujo técnico y tabla de medidas

**MEDIDAS**

**KUBE**

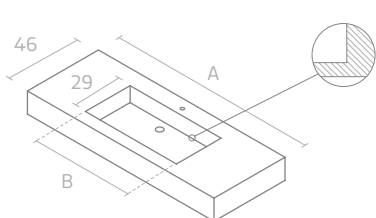

Simple

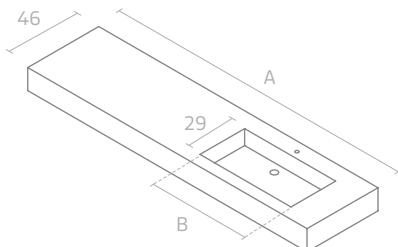

Desplazado

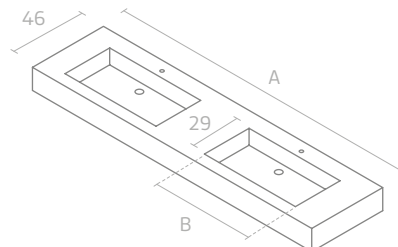

Doble

A	61*	81*	101*	121*	141	161	181	201
B	48	48	59	59	59	59	59	59

\*Sólo encimeras Simples.

Altura faldón	13
Altura copete	3
Altura seno	9

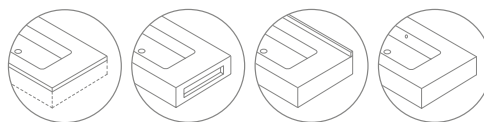

Faldón, toallero, copete y rebosadero opcionales.

**KUBE**

\*imagen única incluyendo dibujos técnicos y tabla de medidas

NMEDKU

**ORGANIC**

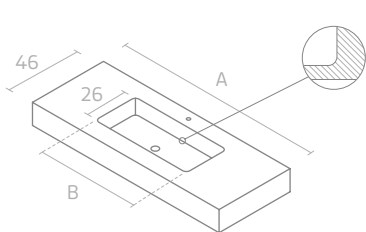

Simple

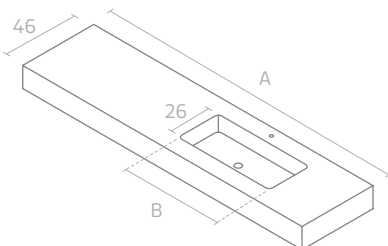

Desplazado

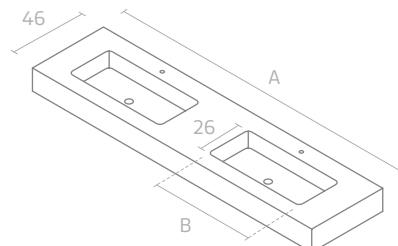

Doble

A	61*	81*	101*	121*	141	161	181	201
B	48	48	59	59	59	59	59	59

\*Sólo encimeras Simples.

Altura faldón	13
Altura copete	3
Altura seno	9

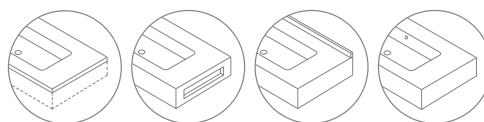

Faldón, toallero, copete y rebosadero opcionales.

**ORGANIC**

\*imagen única incluyendo dibujo técnico y tabla de medidas

NMEDOR

MEDIDAS

**FLAT**

A	61*	81*	101*	121*	141	161	181	201
---	-----	-----	------	------	-----	-----	-----	-----

\*Sólo encimeras Simples.

Altura faldón	13
Altura copete	3

Faldón, toallero y copete opcionales.

FLAT

NMEDFL

\*imagen única incluyendo dibujos técnicos y tabla de medidas